

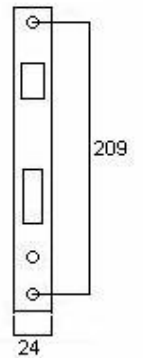

Serie 5490	
Sin cilindro.	
Entrada 60mm.	
Acabado: Acero inoxidable.	
Frente: Redondo.	
Calidad: Alta.	

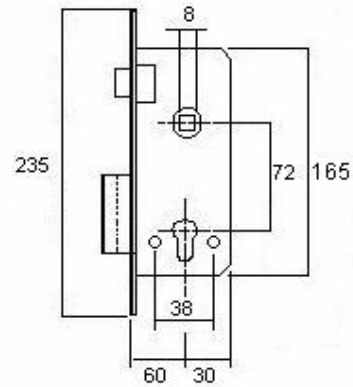

Serie 1790	
Sin cilindro.	
Entrada 45mm.	
Acabados:	
Esmaltada, latón pulido y a. inoxidable.	
Frente:	
Cuadrada y redondo (bajo pedido).	
Calidad: Media Alta.	

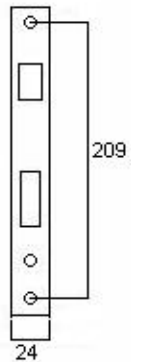
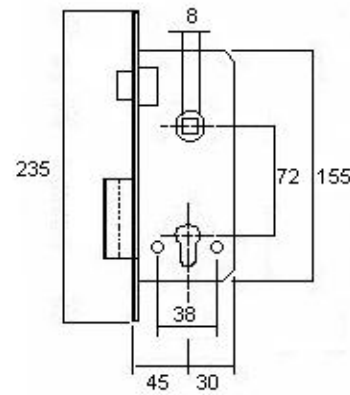

Serie 1491	
Sin cilindro.	
Entrada 55mm.	
Acabado: Esmaltado plata.	
Frente:	
Cuadrada y redondo.	
Calidad: Estandar.	

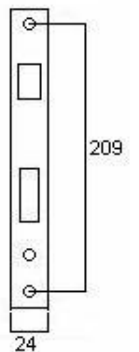
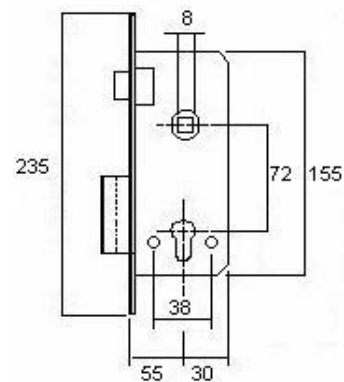

Serie 1424	
Sin cilindro.	
Entrada 55mm.	
Acabado: Latón pulido y acero inoxidable.	
Frente: Redondo.	
Calidad: Media.	

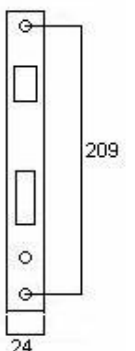
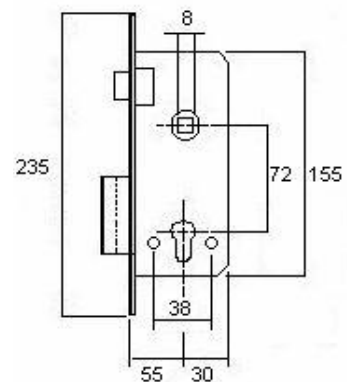



Serie 1723	
Entrada 45mm.	
Acabados:	
Esmaltada, latón pulido y a. inoxidable.	
Frente:	
Cuadrado y redondo (bajo pedido).	
Calidad: Media Alta.	

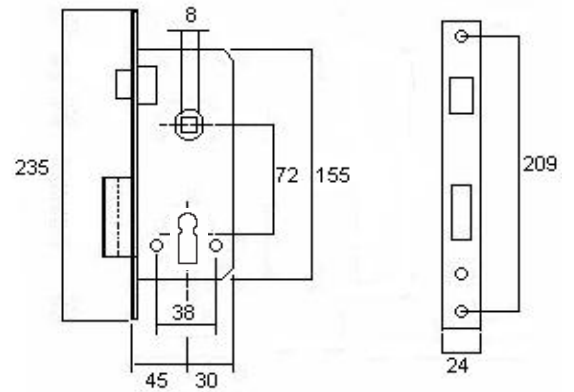

Serie 910	
Entrada 55mm.	
Acabado: Esmaltado plata.	
Frente:	
Cuadrado y redondo.	
Calidad: Estandar.	

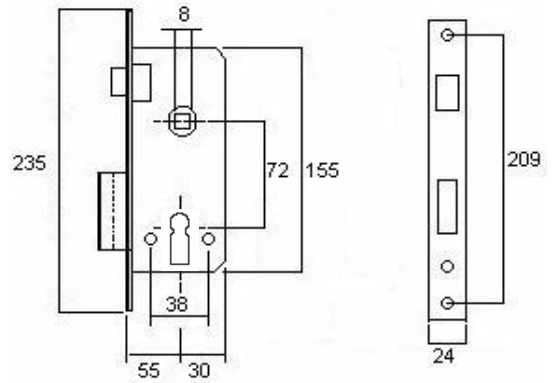

Serie 924	
Entrada 55mm.	
Acabado: Inox. y latón.	
Frente:	
Redondo.	
Calidad: Media.	

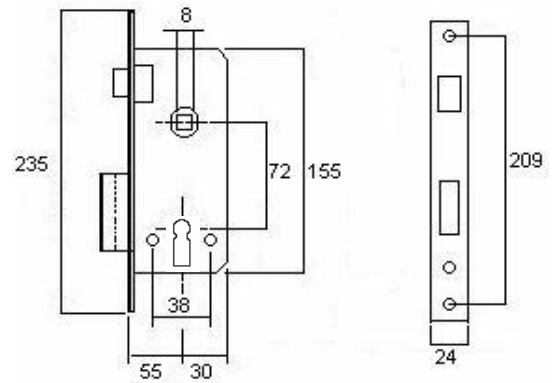

Serie 1101	
Entrada 45 - 55mm.	
Acabado: Esmaltada, Inox. y latón.	
Frente:	
Cuadrado.	
Calidad: Media Alta.	

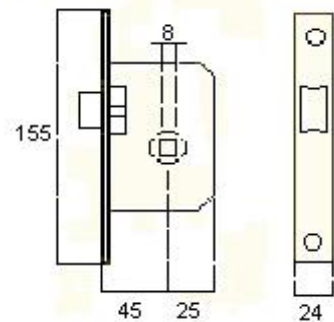

CERRADURAS BAÑO



Serie 1729	
Entrada 45mm.	
Acabados:	
Esmaltada, latón pulido y a. inoxidable.	
Frente:	
Cuadrado y redondo (bajo pedido).	
Calidad: Media Alta.	

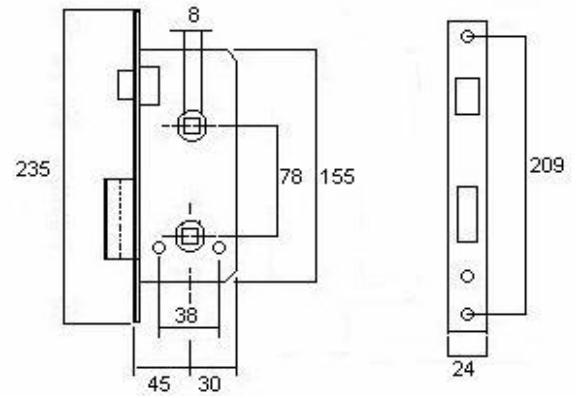

Serie 1120	
Entrada 55mm.	
Acabado: Esmaltado plata.	
Frente:	
Cuadrado y redondo.	
Calidad: Estandar.	

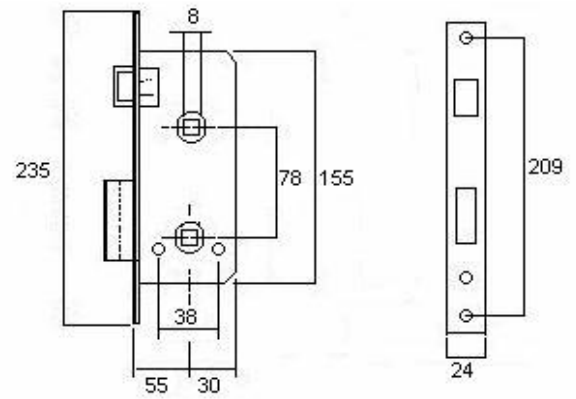

Serie 1124	
Entrada 55mm.	
Acabado: Inox. y latón.	
Frente:	
Redondo.	
Calidad: Media.	

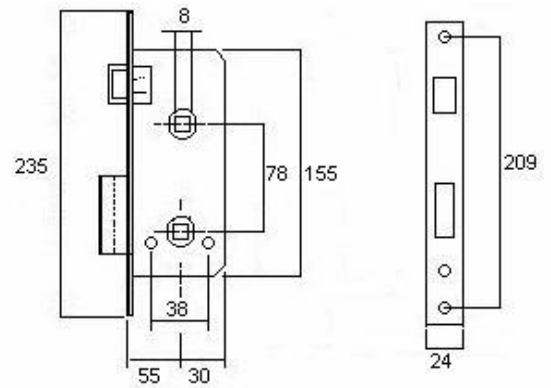

CERRADURAS CORREDERA



Serie 1151	
Entrada 45 - 55mm.	
Acabado: Esmaltada, Inox. y latón.	
Frente:	
Cuadrado.	
Calidad: Media Alta.	

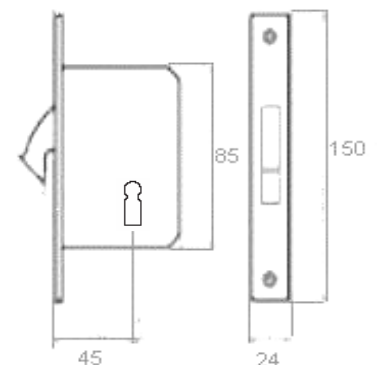

CERRADURAS CORREDERA



Serie 1450		
Entrada: 45 - 50mm.		
Acabado: Esmaltada, Inox. y latón.		
Frente:		
Cuadrado.		
Calidad: Media Alta.		

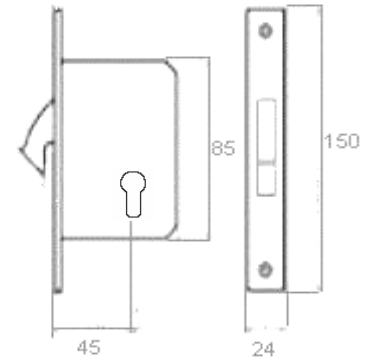

CERRADURAS PALETÓN



Serie 1450		
Entrada: 45 - 50mm.		
Acabado: Esmaltada, Inox. y latón.		
Frente:		
Cuadrado.		
Calidad: Media Alta.		

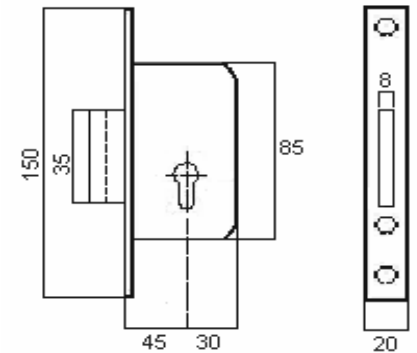

CILINDROS LLAVE NORMAL

Serie 1463Z		
Cilindros especiales con doble función.		
Acabados: Cromado mate y latón mate.		
L	C	D
60	30	30
70	35	35
70	30	40
80	40	40
90	45	45

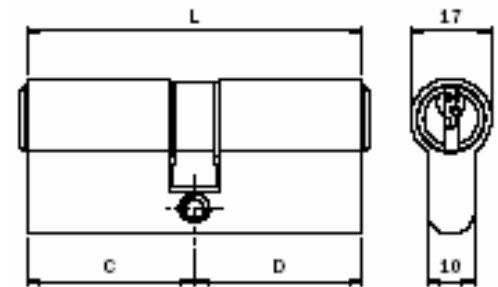

(Medidas especiales consultar)

CILINDROS SEGURIDAD

Serie 1863Z		
Cilindros alta seguridad, con llave especial.		
Acabados: Cromado y latón pulido.		
L	C	D
60	30	30
70	35	35
70	30	40
80	40	40
90	45	45

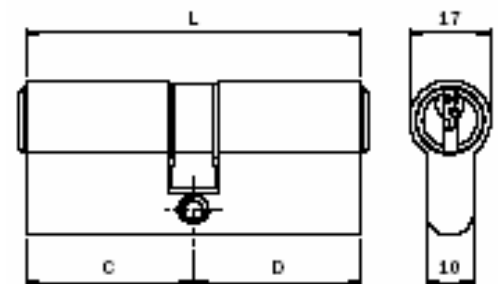

(Medidas especiales consultar)

CERRADURAS LLAVÍN METÁLICAS



Serie 543	
Sin cilindro.	
Entrada 19 - 24mm.	
<u>Acabado:</u> Acero inoxidable.	
<u>Frente:</u> Cuadrado.	
<u>Calidad:</u> Alta.	

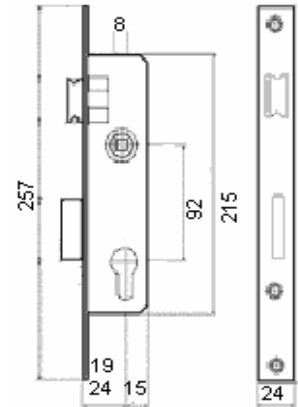

Serie 1438	
Sin cilindro.	
Entrada 25mm.	
<u>Acabados:</u>	
Acero inoxidable.	
<u>Frente:</u>	
Cuadrado	
<u>Calidad:</u> Alta.	

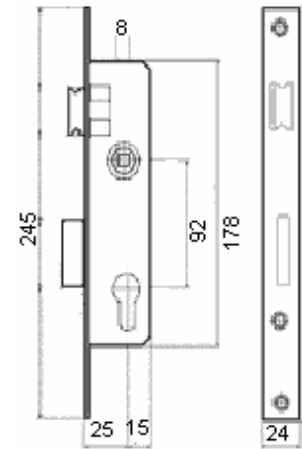

Serie 1436	
Sin cilindro.	
Entrada 25mm.	
<u>Acabado:</u> Inoxidable.	
<u>Frente:</u>	
Cuadrado.	
<u>Calidad:</u> Alta.	

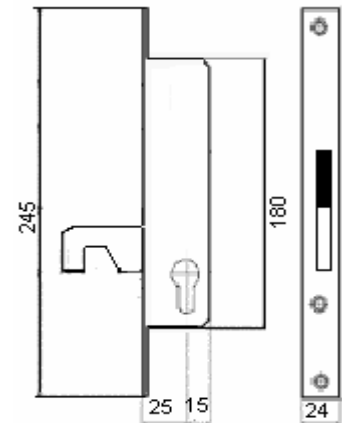

Serie 1424	
Sin cilindro.	
Entrada 55mm.	
<u>Acabado:</u> Latón pulido y acero inoxidable.	
<u>Frente:</u> Redondo.	
<u>Calidad:</u> Media.	

